

UWLTM
The art of superyacht lighting

QT-LED

INSTALLATION GUIDE

UNDERWATERLIGHTS.COM

THE QT-LED RANGE IS DESIGNED AND MANUFACTURED BY UNDERWATERLIGHTS LIMITED

QT-LED

INSTALLATION GUIDE

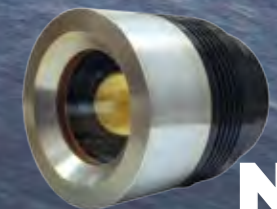
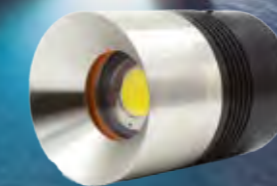
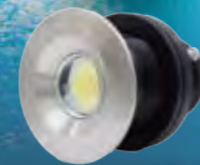
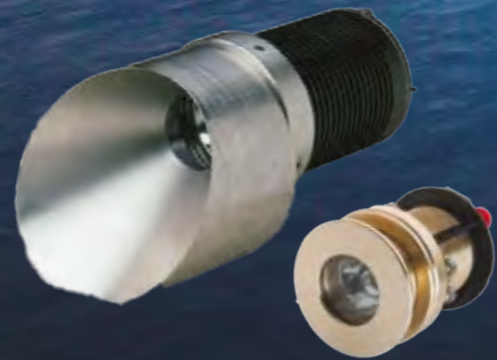

NEW

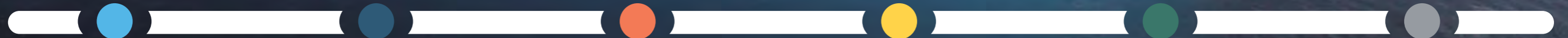

1991

The launch of the worlds first underwater light for yachts - The Bulleyt.

2005

The Bulleyt is superseded by the UL Ti MATE range

2009

We launched our first UL Ti MATE light with LED

2016

QT LED launched using latest technology with flat LED chip producing 100% more lumens

2022

QTS 75 launched using our unique design allowing universal adjustment for ease of installation.

2024

QTE 140 is flush mounted to the hull and has a larger aperture for wider beam angle and universal adjustment.

WWW.UNDERWATERLIGHTS.COM

THE QT-LED RANGE IS DESIGNED AND MANUFACTURED BY UNDERWATERLIGHTS LIMITED

IMPORTANT







IMPORTANT: Please read the instructions completely before proceeding with the installation, for full manual please visit www.underwaterlights.com. Failure to follow the instructions may invalidate your warranty.

This manual contains important information about the installation, operation and safe use of this product.







This information should be given to the owner and/ or operator of this equipment.



Key Reminders



-  The QTS series from UWL is a “through-hull” submersible marine light and is delivered ready for installation and does not require assembly.
-  Maintenance of the light is carried out from inside the hull.
-  The QTS light is suitable for installation into GRP fiberglass, wooden and carbon fibre hulls.
-  Qualified/approved personnel must be used to carry out installation in accordance with ABYC (American Boat and Yacht Council), NMMA, and any other applicable codes and ordinances. Improper installation will create an electrical hazard which could result in death or serious injury to swimmers, installers, or others due to electrical shock, and may also cause damage to property. Always disconnect the power to the light at the circuit breaker before servicing the light. Failure to do so could result in death or serious injury to serviceman, swimmers or others due to electrical shock.
-  Before cutting a hole in the hull, check the hull wall thickness is not greater than the recommended thickness of 80mm.
-  Do not install lights pointing down. Lights found flooded when installed pointing down where they can accumulate water will invalidate any warranty.

Key Reminders



-  Before installing your light, read and follow all warning notices and instructions which are included. Failure to follow safety warnings and instructions can result in property damage, severe injury, or even death.
-  The location of the hole must be below the waterline.
-  Note for cored hulls - after cutting, the exposed surfaces of the hole must be finished to form a solid surface through it. Thus protecting the internal core of the hull.
-  Do not just rely on using excessive amounts of 4200 and ‘hoping’ it seals the core. Failure to seal core may result in core saturation. We recommend using 3M-42005200FC sealant.
-  Salt is an inherently corrosive material. Metal parts and certain natural and man-made surfaces are particularly susceptible to corrosion and deterioration when used in and around salt water. Monitor annually every part of the installation.
-  Lights MUST be bonded. Failure to bond will invalidate any warranty.

Maintenance

-  Marine growth can collect quickly on the light and this can reduce the performance in just a few weeks.

Lights should be cleaned with a boat brush or similar biweekly or as needed to keep the lens of the light clean. Growth varies greatly around the world and maintenance is imperative to the proper operation and longevity of the product. If heavy fouling occurs, barnacles can be removed from the lens using a plastic scraper and moderate pressure. This can be done in the water. If cleaning the lens while the boat is out of the water, apply water to the lens before scraping. Never scrape or try to remove barnacles from a dry lens.
-  Check connections annually for corrosion, if necessary replace.
-  Clean and reapply di-electric grease to silicone gaskets annually.
-  Remove inserts annually for inspection.

Maintenance

-  It is advised to visually inspect the external metal parts of the light for galvanic corrosion on a regular basis. Galvanic corrosion can be a devastating process which can happen quickly and is exacerbated in marinas from neighbouring boats.
-  This light is IPX8 from the front of the light unit. When selecting installation location please make sure the area will not be susceptible to submersion. Please avoid areas near bilge pumps which can sometime become submerged. Submerged lights will void the manufacturers warranty.

Installation Tips

DESIGN

- ✔ QTS model lights are suitable for Fiberglass, GRP, Wooden and carbon fibre using suitable mounting hardware.
- ✔ If positioning lights on a transom, odd numbers look better, i.e positioning one centrally. 3 looks better than 2, 5 looks better than 4.
- ✔ Blue lights seem brighter than white lights with a better beam spread because they are more perceptible to the cones in the human eye.
- ✔ Please follow instructions with any accessories used to protect warranty coverage and to ensure product longevity.
- ✔ Check the inside spacing of the boat to ensure that if maintenance is required, there is enough space on the inside of the boat to remove the insert.
- ✔ All lights will look different in brackish or dark water. Different colors may suit different environments

DEPTH

- ✔ Ideal mounting depth is 10"(250mm) to top of fixture.
- ✔ Minimum mounting depth is 3"(75mm) to top of fixture.
- ✔ Ideally mount your lights at similar depths when using underwater to ensure matching color consistency through the water. Deeper lights will look duller and possibly differ in color to shallower mounted units.

SPACING

- ✔ If positioning lights on a transom, take into consideration swim platforms and obstacles that may block the initial portion of the light.
- ✔ The recommended transom spacing between lights is 1/1.5M-3/5M Port & STB.

Installation Tips

- ⚠ Never leave the bare cables unprotected. Water deposits in the connectors and cables will corrode the cables causing the light to fail and will NOT be covered under warranty.
- ⚠ Use a certified fuse box to make all connections.
- ⚠ Mount drivers in a dry location. Drivers should not sit in standing water at any time.
- ⚠ For the QTS system, please check wattage per unit when calculating wire size. 12awg wire will hold 25amps on runs 0-50' and 18amps over 50'
- ⚠ Use ferruls for all connections in the driver.
- ⚠ We recommend using the new Junction box for all DC installation.

Installation Tips

- ✔ Test units before installation.
- ✔ Make sure that when installing the underwater light, the entire flange of the light is coated in sealant to prevent any water ingress into the hull from rear of the unit.
- ✔ When switching lights on for the first time, take into consideration water clarity, ambient light etc as first time impressions can be sometimes less than expected.
- ✔ After completing the installation procedure it is highly recommended to coat the body face with antifouling.
- ✔ N.B. rear of light is rated to IP65 splashproof - Do not install near bilge pumps or areas which accumulate water

BONDING

It is essential to bond the lights to the anodes or a cathodic protection system via the earth screw located on the securing ring of the light. Do not put bonding screw on any other part of the light as it will not create the correct contact.

QTS-100 INSTALLATION (MAXIMUM HULL THICKNESS 80MM & OPERATION INSTRUCTIONS)

! Qualified/Approved personnel must be used to carry out installation. Before cutting a 74mm hole in the hull, check the hull wall thickness is not greater than 80mm. The location of the holes must be below the waterline. After finishing the hole surface, check Body (1) can be inserted.

! Note for cored hulls - After cutting, the exposed surfaces of the hole must be finished to form a solid surface through it. Thus protecting the internal core of the hull. The wall thickness of the hole should be less than 5mm-0.25inch.

Apply 3M-4200/5200FC sealant to the Body (1) flange. Slide the body into the hole and from inside the hull put the 'compensating ring' (3) on and screw the 'securing ring' (4) up hand tight. Gently tighten the 'adjustment screws' (7) so the compensating ring is flush to the hull and the sealant has flowed completely around the flange and hull.

! Do NOT overtighten the bolts as this will squeeze the sealant from the surfaces. Allow the sealant to solidify and remove the surplus. Finally tighten the bolts (7) to 4Nm/3ft.lbs.

! It is not necessary to remove the heatsink parts (2,5 and 6) when carrying out the installation.

! Before fitting the new LED heatsink (2) ensure the barrel part of the body (1) and then lens is clean. Use silicone spray to lightly coat the heatsink (2), clamp ring (5) and sealing orings (6). Slide the heatsink (2) into the barrel and tighten the knurled clamp ring (5) to secure the heatsink (2) into the body. When the heatsink (2) cannot be rotated the clamp ring (5) has secured all in place. If this is not done it will cause overheating of the LED and possible water ingress and the LED could fail. This would also invalidate any warranty.

! Caution do not operate lights unless totally submerged. Maximum cable length should not exceed 6m due to voltage drops. After completing the installation procedure it is highly recommended to coat the body (1) face with anti fouling and the lights must be bonded to the anodes or a cathodic protection system as show below.

! Earth light for cathodic protection tighten the earth screw (8) on the securing ring (4) so that it bites into the screwed barrel. Then connect your bonding cable to the earth screw and use the nut to hold this in place. Check the continuity to the front face. This prevents galvanic corrosion and warranty will be invalid.

! ALL EXISTING WIRING, BREAKERS AND FUSES MUST BE CHECKED BEFORE UPGRADING BY A REPUTABLE INSTALLER OR SURVEYOR

! The lights must be installed onto a flat (not curved surface). Mount on transom or side hull only, it is not recommend to install the light pointing directly down unless in a dry area.

! The light is supplied with the LED heatsink (2) done up tight. You must check this is still done up hand tight with the clamp ring (5) after installation.

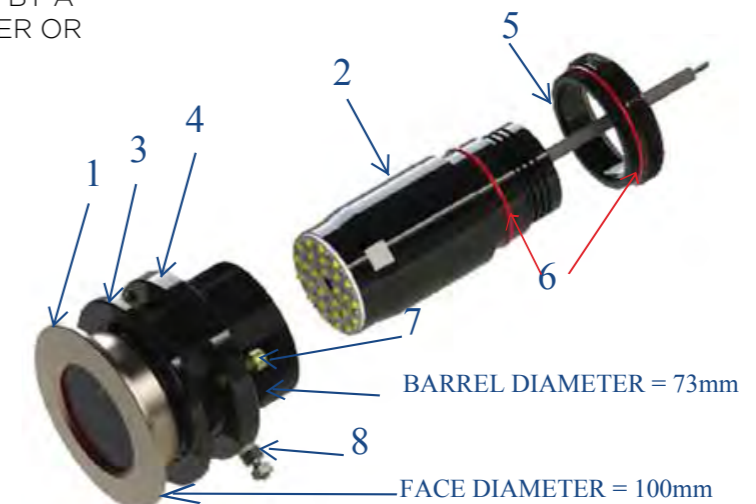

ITEM 8

EARTH SCREW

TECHNICAL SPECIFICATION

Supply voltage: 110-240vac Maximum 150w 1.4-0.7 amps
 LED Driver: Remote
 LED: Cool white or blue
 Body Material: Titanium & 5083 aluminium hard black anodised LED
 Lamp Life: 20,000 hours

| QTS 100 Description | Qty. |
|-----------------------------|----------|
| 1; BODY | 1 |
| 2; LED HEAT SINK | 1 |
| 3; COMPENSATING RING | 1 |
| 4; SECURING RING | 1 |
| 5; CLAMP RING | 1 |
| 6; 'O' RINGS | 2 |
| 7; ADJUSTMENT SCREWS | 3 |
| 8; EARTH SCREW | 1 |



QTLED 150w DRIVER HP3 DALI

Electrical Installation Instructions for QT/QTS-75, QTS100 & 130 and QTE 140

- ⚠ Qualified /Approved personnel must be used to carry out electrical installation
- ⚠ Cable entry glands are M20 for supply power and M12 for DALI Cable – Please refer to technical sheet for the enclosure dimensions.
- ⚠ Power Supply to driver 110-240VAC 50/60Hz
- ⚠ Recommend only six lights per circuit. See diagram opposite
- ⚠ The driver enclosure must have a minimum distance of 50cm from the LED projector
- ⚠ The driver enclosure must be fitted a minimum of 60cm above tank top or bilge
- ⚠ The driver enclosure must have airflow on all surfaces. Use the 2cm spacers for the back surface when securing
- ⚠ The driver must be installed vertically as shown in the picture below or next page
- ⚠ The maximum ambient temperature of 50c must not be exceeded
- ⚠ The LED projector is supplied with 6m of cable with the plug and socket already connected. This cable can be extended.

The information below is ADVISORY only.

- Please check with the installer who is responsible for the design and installation of the system.
- DALI permits a combination of star and series connections using two core cable for the data connection.
- All drivers have their own individual numbers – when setting up the DALI system you can readdress them all automatically using your lighting control system as long as it DALI compatible.
- UWL are not responsible for the addressing of the drivers.

ADVICE SIX DRIVERS TO ONE CIRCUIT
TOTAL CURRENT = 3 AMPS (RECOMMEND 3 CORE X 1.5mm sq)

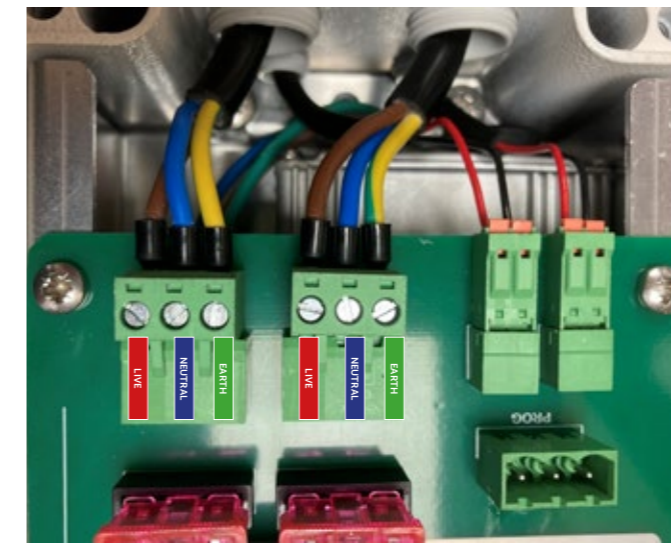
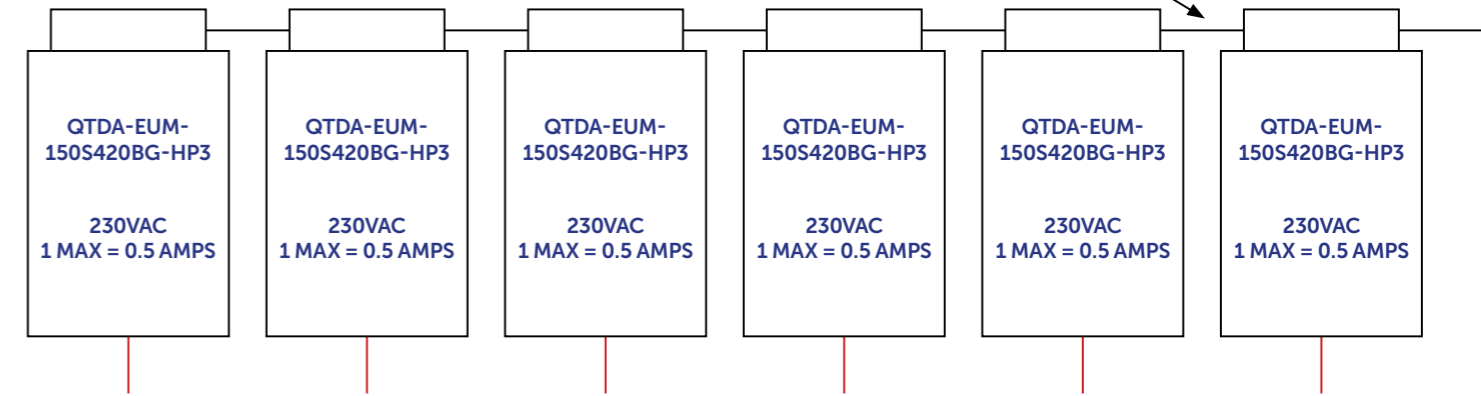

Power & DALI connection for driver



Driver enclosures pace distance

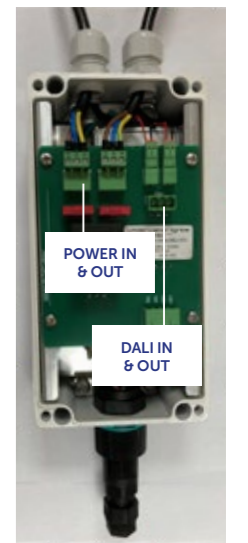

Driver and Enclosure part number QTDA-EUM-150S420BG-HP3-DALI

- INPUT 110/240vac 50-60Hz.
- AMP Draw 1.4a - 0.7a
- Maximum LED wattage 150 watts
- OUTPUT Max 55 VDC

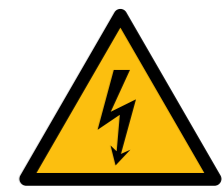

IMPORTANT INFORMATION

DISCONNECT POWER BEFORE DISMANTLING LED MUST BE CONNECTED TO THE DRIVER BEFORE APPLYING POWER

QTS100/130 BONDING

EARTH LIGHT INSTRUCTIONS FOR CATHODIC PROTECTION

Tighten the earth screw on the securing ring so that it bites into the screwed barrel. Connect this to the hull anode or cathodic protection system.

Check there is continuity to the front face. This prevents galvanic corrosion.



Earth tab and screw

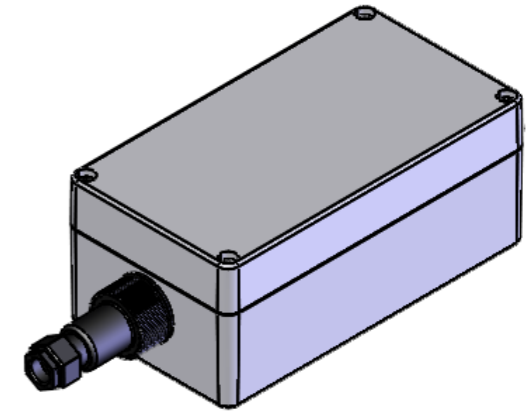
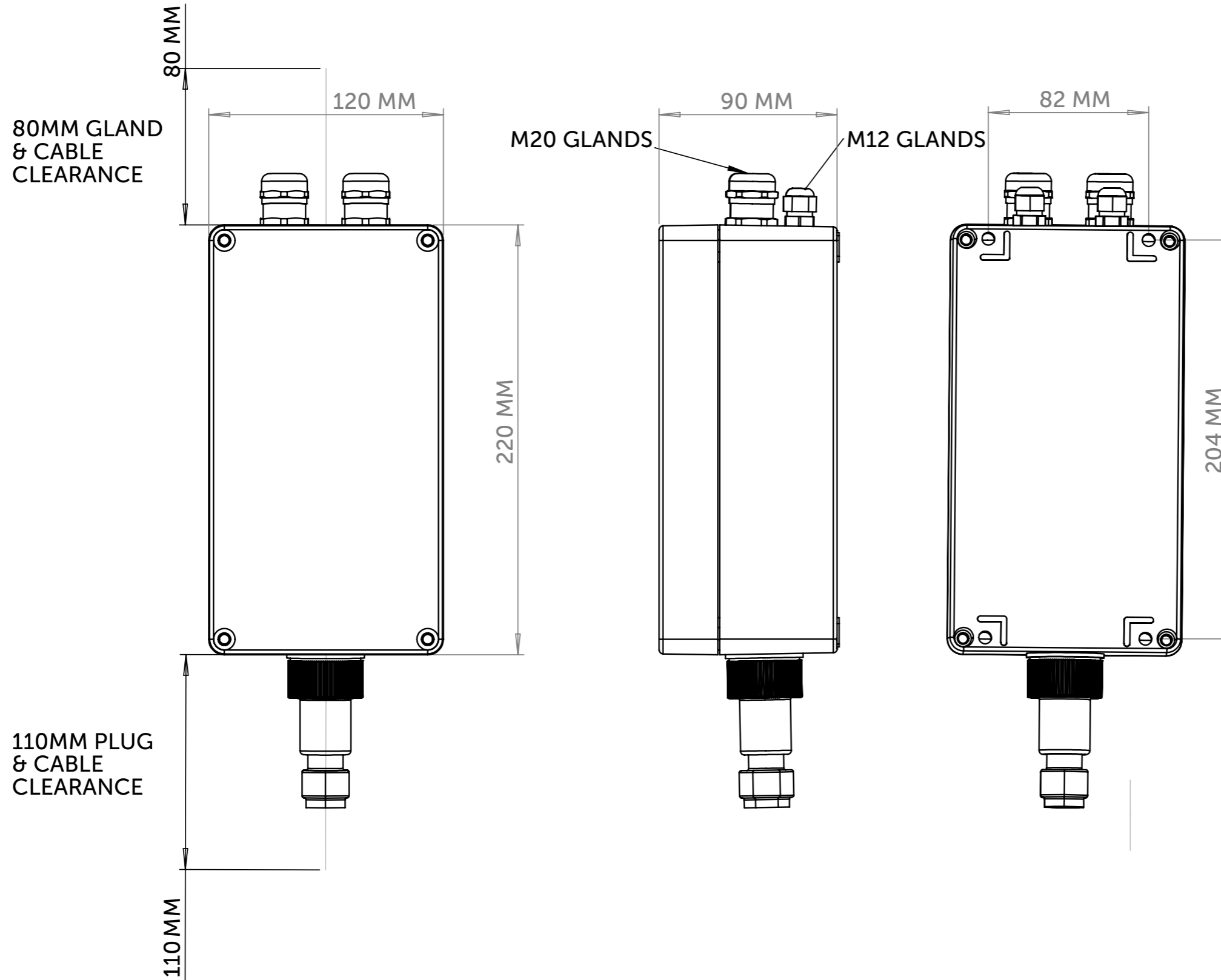

Warranty Statement

Warranty Statement Underwater Lights Limited (UWL) stands by its products. In general terms, the company gives a full 2 year's manufacturer's warranty on all its products from the date of sale, provided that the products have been installed correctly per the installation instructions available on the website at: www.underwaterlights.com. To submit a claim, please read and follow the guides lines in the warranty statement below; Section 6: Making a claim. Please note, claims may be rejected if the troubleshooting guidelines are not completed, photographs of the unit and area where it is installed are not included with claim submission, or the problem is related to how and where the unit was installed. Please note that all metal parts corrode in salt water. The primary factors affecting corrosion are not directly related to our products and accordingly UWL cannot be held responsible for corrosion-related defects, this includes but is not limited to where water has been allowed to enter the cable as a result of immersion in water during the installation or improper sealing of connections. Please note corrosion will be particularly aggressive if installation and/or bonding has not been correctly undertaken; or if stray currents are active in the vicinity of the boat. (Claims will also be rejected if bonding of the units has not been installed). Claims will also be rejected if the units were found to be installed in an inappropriate position without prior approval from Underwater Lights LTD. As made clear on the installation sheet included with your lights original packaging, lights should not be installed pointing down where they can accumulate water. Underwater Lights LTD products are tested and approved to IPX8 protection from the front face ONLY. Submersion from behind may result in failure of equipment and is not covered by this warranty policy. The installer and operator must engage in preventative action to ensure the back of the light units located inside the boat do not become submerged at any time. Floods, pump failures and faulty hatch seals which lead to equipment failure is not covered by this warranty policy. Color variation commonly occurs within the LED manufacturing process. Whilst UWL makes every effort to match the color of any lights there may be a noticeable difference when installed next to existing lights. UWL does not warrant this color variation on lights. All UWL products must be connected to the anodes or cathodic protection system and checked to ensure there is good connection to the front face of the light. Failure to bond lights during install will invalidate the lights warranty. Information on bonding procedure is provided with your lights. All Underwater Lights products must be installed by qualified marine installers and certified electricians. No warranty will be honored if lights are damaged by improper installation either in terms of placement (see above) or sound electrical standards are not followed. Underwater Lights LTD can advise on light locations and simple circuit diagrams, however, we will not advise and therefore have no liability when it comes to installation by a 3rd party in relation to power distribution, electrical protection or installation in hazardous areas. UWL reserves the right to change the design, range and components without any prior notification either written or implied. The detailed terms and conditions of this warranty are set out below:

1: WARRANTY OF QUALITY 1.1 In the case of LED goods manufactured and sold by UWL, a company incorporated in England and Wales (registered number 2348038) and whose registered office is at The Great Dunton Forge, London Road, Dunton Green, Kent, United Kingdom, TN13 2DG (the "Goods" and the "Company", respectively), the Company warrants to the purchaser of the Goods (the "Buyer") Conditions and unless otherwise notified) upon delivery (whether installed or not). That (subject to the other provisions of these) The Goods supplied shall be of satisfactory quality within the meaning of the Sale of Goods Act of 1979. 1.2 the Company shall not liable for a breach of the warranty in Condition 1.1 unless: 1.2.1 the Buyer gives written notice of the defect to the Company, and to the carrier if the defect is as a result of damage in transit, within 14 days of the time when the Buyer discovers or ought to have discovered the defect; and 1.2.2 the Buyer has the obligation to provide all the requested information where is reasonably possible and provided a truthful statement of all information requested in relation to the claim. 1.2.3 the Buyer returns such Goods to the Company's place of business at the Buyers cost, regardless of the outcome of the claim. 1.2.4 the Company is given a reasonable opportunity after receiving the returned Goods for the examination to take place at the company's place of business. 1.3 the Company shall not be liable for a breach of the warranty in Condition 1.1 if: 1.3.1 the Buyer makes any further use of such Goods after giving such notice; or 1.3.2 the defect arises because the Buyer failed to follow the Company's oral or written instructions as to storage, transportation, installation, commissioning, modification, use or maintenance of the Goods or (if there are none) good trade practice; or the defect arises from the corrosion of metal parts or the failure of the Buyer to ensure that Goods are installed correctly, installed in approved locations, bonded correctly and that there are no active stray currents in the vicinity; or 1.3.3 the defect arises as a result of any default of, or caused by, the Buyer or (without limitation) as a result of misuse, abuse, improper installation, neglect, improper shipping by a party other than the Company; or 1.3.4 the Buyer alters, repairs or modifies such Goods without written consent of the Company; or 1.3.5 the defect arises due to a cause beyond the Company's reasonable control, such as: act of God, explosion, flood, tempest, re or accident, including without limitation lightning; war or threat of war, national emergency, sabotage, terrorism, insurrection, protest, riot, epidemic, civil disturbance or requisition; Acts, restrictions, regulations, by-laws, prohibitions or measures of any kind on the part of any governmental, parliamentary or local authority; import or export regulations or embargoes; strikes, lock-outs or other industrial actions or trade disputes (whether involving employees of the Company or of a third party); restraints or delays affecting carriers or inability or delay in obtaining supplies of adequate or suitable materials; or power failure or breakdown in machinery. 1.3.6 where the Company has notified the Customer directly of in service modification(s) deemed necessary to further protect the Goods from damage have not been followed. 1.3.7 where a claim has been made where the Goods ownership is in dispute. 1.3.8 where the parts were not purchased from an authorized outlet.

1.3.9 where the goods were purchased via the internet from the United States but were not shipped to an address or installed in the United States. 1.4 Subject to Conditions 1.2 and Condition 1.3, if any of the Goods do not conform with the warranty in Condition 1.1 the Company shall at its option repair or replace such Goods (or the defective part) without charge for labor or parts or refund the price of such Goods at the original purchase price. The Company shall pay for the return transportation to the Buyer of such repaired or replaced Goods. 1.5 Any Goods replaced shall belong to the Company and any such repaired or replacement Goods shall be guaranteed on these terms for the unexpired portion of the warranty period of the warranty in Condition 1.1.

2: LIMITATION OF LIABILITY 2.1 These Conditions set out the entire financial liability of the Company (including any liability for the acts or omissions of its employees, agents and sub-contractors) to the Buyer in respect of: 2.1.1 any breach of these Conditions; 2.1.2 any defect in the Goods; 2.1.3 any use made or resale by the Buyer of any Goods, or of any product incorporating any of Goods; and 2.1.4 any representation, statement or tortious act or omission including negligence arising or in connection with the contract with the Buyer. 2.2 All warranty, conditions and other terms implied by both UK law are, to the fullest extent permitted by law, excluded from the contract with the Buyer. 2.3.1 nothing in these conditions excludes or limits the liability of the Company; 2.3.1 for death or personal injury caused by the Company's negligence; 2.3.2 under both UK law; 2.3.3 for any matter which it would be illegal for the Company to exclude or attempt to exclude its liability; or 2.3.4 for fraud or fraudulent misrepresentation. 2.4 Subject to the above Condition 2.3: 2.4.1 the Company's total liability in contract, (including without limitation negligence or breach of statutory duty), misrepresentation, restitution or otherwise, arising in connection with the performance or contemplated performance of the contract with the Buyer or (without limitation) in respect of the Goods shall be limited to the original purchase; and 2.4.2 the Company shall not be liable to the Buyer for any pure economic loss, loss of profits, loss of business, loss of contracts, damage to property, depletion of goodwill or otherwise, in each case whether direct, indirect, or consequential, or any claims for consequential whatsoever (however caused) which arise out of or in connection with the contract with the Buyer or (without limitation) the Goods.

3: THIRD PARTY RIGHTS 3.1 No term of any Contract formed between the Buyer and the Company shall be enforceable by virtue of the Contracts (Rights of Third Parties) Act 1999 by any person that is not a party to it.

4: APPLICABLE LAW 4.1 Each of (a) the sale of the Goods to the Buyer, (b) these conditions, and (c) any disputes or claims arising there from or in connection therewith shall be governed by and construed in accordance with the law of England; and the Buyer and the Company irrevocably agree that the Courts of England have exclusively jurisdiction to settle any dispute or claim that arises out of or in connection with the foregoing.

5: GREY MARKET INTERNET POLICY 5.1 Grey marketed products continue to be a threat to our worldwide distribution and dealer network. In order to proactively discourage this activity by Internet resellers of our product, UWL will not honor the warranty of products purchased via the grey market through internet resellers. The following notice is stated on UWL's warranty cards, website and all internet sellers will be required to post the same notice. **WARRANTY NOTIFICATION:** UWL products purchased by an end-user from a United States dealer via the Internet are covered by this warranty, only if the products are delivered and installed within the United States. The warranty is void if the product is delivered or installed outside the United States. Proof of purchase and installation will be required. Product installed by OEM will be warranted when shipped as part of a new boat package.

6: MAKING A CLAIM 6.1 Irrespective of how the products were fitted or by whom, if you discover that there may be a problem with the products you must notify either your local dealer or UWL within 14 days. 6.1.1 When you discover a problem, we ask that the products are not used until they are fixed. This will minimize any further damage. We recommend the product be disconnected from its power source to prevent accidental use and covering any open connections, of the with an electrically safe and waterproof solution to prevent water entering the cable or product. 6.1.2 If a claim is accepted the part will be replaced on a "like for like basis". No refunds will be given. 6.1.3 If you require a part urgently from us, you would be required to purchase a new one from us. You then have a maximum of 30 days to return the faulty part to us. We will investigate and if the product has a problem due to our manufacturing, we will provide a full refund. If you do not think that you can return the part to us within the 30 days please contact the Service Manager. If the product is not returned within the time limit without speaking to the Service Manager to obtain an extension to the 30 days, the claim will be closed and no refund given. 6.1.4 If we are unable to find a problem with the part, we will inform you of the outcome. We can provide guidance to possible reasons for the fault. UWL is not liable for or can fix problems with equipment & installations that are not purchased from UWL. The returned product can be returned to you at your request. 6.1.5 If you feel unhappy with any part of the process of claiming please let us know. 6.1.6 Please take pictures at every stage of the process. Claims sent without pictures will be automatically rejected until photographs of the lights and area it is installed in are supplied. 6.2 Products supplied and fitted by a dealer: 6.2.1 If you had the products installed by one of our dealers, we ask that you contact them and ask that they check the installation and establish the cause of the problem prior to making a claim. If you are not local to the installer, please visit our website (www.underwaterlights.com) to find the authorized dealer closest to you. Many problems are due to environmental contamination, issues with the installation or electrical issues which are external to the lighting system and can be resolved without the need for the removal of the product or initiation of the warranty procedure. An example for environmental contamination, make sure your lenses are free of growth when conducting your tests. 6.2.2 Locate your original purchase invoice for the products showing product purchased within last 2 years and contact the dealer you purchased the products and / or who fitted them. 6.2.3 Your dealer will contact us and together we will resolve your issues and together we will investigate the part. 6.2.4 If the problem is found not to be due to the manufacture of the product, repair or replacement will fall outside of this warranty coverage and the buyer will be liable for all costs. 6.2.5 If you require a part urgently from us, you would be required to purchase a new one from us. You then have a maximum of 30 days to return the faulty part to us. We will investigate and if the product has a problem due to our manufacturing, we will provide a full refund. If you do not think that you can return the part to us within the 30 days please contact the Service Manager. If the product is not returned within the time limit without speaking to the Service Manager to obtain an extension to the 30 days, the claim will be closed and no refund given. 6.2.6 If we are unable to find a problem with the part, we will inform you of the outcome. We can provide guidance to possible reasons for the fault. UWL is not liable for or can fix problems with equipment & installations that are not purchased from UWL. The returned product can be returned to you at your request. 6.3 Products supplied by a dealer but fitted by the Buyer: 6.3.1 If you installed the products yourself, before making contact we ask that you follow the troubleshooting chart for your product. When following the appropriate troubleshooting

ing chart, it is helpful to complete the appropriate warranty claim information sheet. Copies can be found in the troubleshooting section of the manual included with the product or alternatively it can be download from our website. 6.3.2 If after following the troubleshooting guide, you still believe that the problem still exists with our product you will need to contact the dealer that you purchased the product(s) from. If you are unable to do this you may contact any dealer / distributor in your local area (a list can be obtained either from our website (www.underwaterlights.com) or by contacting our Head Office. 6.3.3 You will be required to provide the information recorded on the warranty claim information sheet and have the copy of your purchase invoice for the products along with pictures of the damaged unit and area it is located in. 6.3.4 When contacting your dealer you will be asked for the details from the warranty claim information sheet. During this time the dealer will complete the appropriate warranty claim form that will be returned along with the part. 6.3.5 When you have made contact with the dealer please follow their instructions. 6.3.6 If you are unable to contact a dealer you may wish to contact UWL directly. To contact the Service Manager either call our UK office on +44 (0) 1732 455753 or email uw@underwaterlights.com. 6.4 If you are unable to locate a dealer close by or the units were purchased directly from UWL: 6.4.1 Before making contact we ask that you follow the troubleshooting chart for your product, when following the appropriate troubleshooting chart we find that it is helpful to complete the appropriate warranty claim information sheet. Copies can be found in the troubleshooting section of the manual included with the product or alternatively it can be download from our website (www.underwaterlights.com). 6.4.2 If after following the troubleshooting guide, you still believe that the problem still exists with our product you will need to contact the Service Manager at UWL. Please contact the Warranty Department at our UK Head Office at: Underwater Lights Limited The Great Dunton Forge, London Road, Dunton Green, Kent, United Kingdom, TN13 2TD Tel: +44 (0) 01732 455753 Fax: +44 (0) 01732 743233 Email uw@underwaterlights.com 6.4.3 When you make initial contact you will be required to provide the information recorded on the warranty claim information sheet and have the copy of your purchase invoice for the products. You will also be required to send photographs of the unit along with photographs of the area which the units are installed. The Service team will review with you your problem and where possible advise on any further checks that may be required. If the test results show you do have a problem, you will be issued with a Warranty Claim number. The Claim number (WC#) is unique to your claim and should be used in all correspondence and attached to the returned parts. 6.4.4 You will be required to return the faulty part with the attached WC number to the address provided to you. 6.4.2. The return of the part is at your expense. 6.4.5 The part will be investigated and if the cause is established to be a manufacturing error with the components is found we will return a replacement part to you. 6.4.6 If you require a part urgently from us, you would be required to purchase a new one from us. You then have a maximum of 30 days to return the faulty part to us. We will investigate and if the product has a problem due to our manufacturing, we will provide a full refund. If you do not think that you can return the part to us within the 30 days please contact the Service Manager. If the product is not returned within the time limit without speaking to the Service Manager to obtain an extension to the 30 days, the claim will be closed and no refund given. 6.4.7 If we are unable to find a problem with the part, we will inform you of the outcome. We can provide guidance to possible reasons for the fault. UWL is not liable for or can fix problems with equipment & installations that are not purchased from UWL. The returned product can be returned to you at your request.

Underwater Lights Limited
The Great Dunton Forge, London Road,
Dunton Green, Sevenoaks, Kent, TN13 2TD UK.
T: +44 (0) 1732 455753 • F: +44 (0) 1732 743233
E: uw@underwaterlights.com
www.underwaterlights.com

Underwater Lights Limited

The Great Dunton Forge, London Road,
Dunton Green, Sevenoaks, Kent, TN13 2TD UK.
T: +44 (0) 1732 455753 • F: +44 (0) 1732 743233
E: uw@underwaterlights.com
www.underwaterlights.com

VALID FROM MAY 2025

© 2025 Underwater Lights Limited All Rights Reserved.

Underwater lights limited reserves the right to change specifications without notice.